

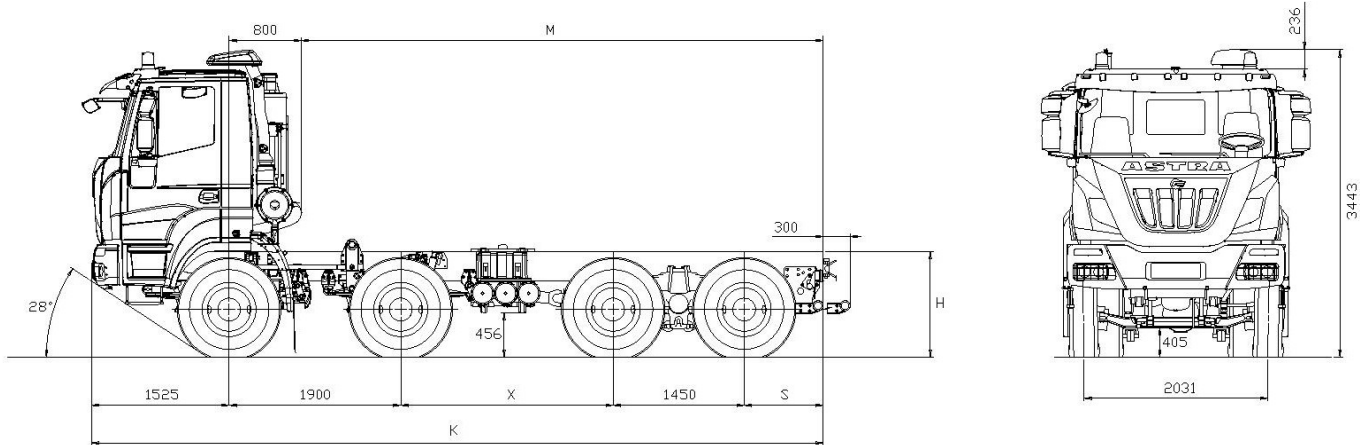

**chassis 8x4
HD84.38**

DIMENSIONS (MM)

X	K	M max(*)	S	H		TURNING DIAMETER (wall to wall)
				unloaded	loaded	
4250	8425	6100	1200	1189	1129	19100
4500	8675	6350	1200	1189	1129	19900
4750	8925	6600	1200	1189	1129	20700
5000	9175	6850	1200	1189	1129	21500
5250	9425	7100	1200	1189	1129	22200
5500	9975	7650	1500	1189	1129	23000
6000	10475	8150	1500	1189	1129	24600
6960	12035	9710	1500	1189	1129	27500

(*) M max.: indicative value to be confirmed by bodybuilder.
(Tyres 13R22.5)

WEIGHTS (KG)

X	Distribution net weight(*)			Max technical weight			
	Front axles	Rear axles	Net Weight	Front axles	Rear axles	Gross Vehicle Weight	Gross Combination Weight
4250	6700	4120	10820	16000 18000 (1) (2)	32000 (2)	50000 (2)	104000
4500	6685	4160	10845				
4750	6670	4195	10865				
5000	6695	4270	10965				
5250	6690	4300	10990				
5500	6670	4365	11035				
6000	6660	4420	11080				
6960	6600	4535	11135				

(*) Net weight including driver with tanks filled to at least 90%, equipped with standard equipment according to the manufacturer's specifications and, if fitted, the mass of the bodywork, spare wheels and tool box.

(1) With tyres on front axles 385/65R22.5 or 325/95R24 and reinforced springs (OPT).

(2) With tyres 325/95R24 or max speed limited to 70 Km/h depending on pneus type and brand.

Higher speeds are allowed with load reductions subject to Astra technical office approval.



ENGINES

CURSOR 13 turbo intercooler euro 3 diesel injection/cycle with electronic unit injection pumps. Single block head, four valves per cylinder, light alloy pistons. Total displacement: 12.882 cm³. Bore for stroke: 135 x 150 mm. 6 in-line cylinders. Water cooling. Dry air filter with safety cartridge. Vertical muffler.

Max.power(EEC) 279 KW (380 HP) @ 1900 rpm
 Max.torque(EEC) 1800 Nm (183 kgm) @ 900 - 1500 rpm
 Turbine with waste gate valve



GEARBOX

Manual **ZF 16S2220TO** Ecosplit 4 technology gearbox with servoshift, 16 synchronised forward speeds + 2 reverse:

On request:

ZF 16S2320TD

		Speed [kph] calculated at maximum power rpm																		
		Gears / Gear ratios																		
Gearbox model	Rear axle ratio	1st	2nd	3rd	4th	5th	6th	7th	8th	9th	10th	11th	12th	13th	14th	15th	16th	rev. 1st	rev. 2nd	
16S 2220 TO		13.8	11.54	9.49	7.93	6.53	5.46	4.57	3.82	3.02	2.53	2.08	1.74	1.43	1.2	1.00	.84	12.92	10.8	
	5.01	5.62	6.72	8.18	9.78	11.88	14.21	16.98	20.31	25.69	30.67	37.30	44.59	54.26	64.66	77.59	92.37*	6.01	7.18	
16S 2320 TD		16.41	13.8	11.28	9.49	7.76	6.53	5.43	4.57	3.59	3.02	2.47	2.08	1.7	1.43	1.19	1.00	15.36	12.92	
	5.01	4.73	5.62	6.88	8.18	10.00	11.88	14.29	16.98	21.61	25.69	31.41	37.30	45.64	54.26	65.20	77.59	5.05	6.01	

(*) Max limited speed 90 km/h. Other speeds available, subject to the Astra technical office approval.



CLUTCH

Single dry plate, diameter 17". Pull type engagement with diaphragm spring. Hydro-pneumatic power steering engagement control, with driven disk wear recovery slave cylinder.

On request: Ceramic clutch 17".



AXLES

FRONT

Steering axle, hot moulding in high tensile steel. Wheel stud protection.

REAR

Two drive axles in tandem. Double reduction: central with beveled pair, final in the wheel hubs by means of epicycloidal assembly. Torque distribution between the axles by means of a distributor fitted on the intermediate axle. Differential lockable from driver seat. Tandem assembled to the chassis by reaction rods with silentblocks.

On request: Rear-axle ratio 1:3,793; 1:4,229; 1:5,009; 1:5,558; 1:6,095; 1:6,588.



SUSPENSIONS

FRONT

Parabolic springs, n° 3 leaves 26x90 mm, hydraulic shock absorbers. Standard stabilizer bar on 1st axle.

On request:

Stabilizer bar on 2nd axle.

Reinforced parabolic springs, n° 4 leaves 26x90 mm (mandatory with 9t version).

REAR

Parabolic springs, swiveling on central pin: n° 4 leaves 40x100mm, torque bars and stiffening brackets. Standard stabilizer bar on 4th axle.

On request:

Stabilizer bar on 3rd axle.

Extra-reinforced conventional springs, n° 10 leaves 25x100 mm



CHASSIS

Special steel with high tensile strength limit, two flat and parallel side members (width 820 mm.), C section (320x90x10mm), cross members bolted to the frame. R.B.M. (Rail Bending Moment): 202.020 Nm (20.593 Kgm.). Steel front bumpers with headlamp protection grids, front maneuvering hook, rear underrun bar, rubber mud-guard 2nd axle, steel fuel tank capacity 300 litres.



TYRES

FRONT: 13R22.5 156/150 G Single tubeless

REAR: 13R22.5 156/150 G Twin tubeless

Spare wheel on the chassis.

Other Possible combinations:

315/80 R22,5 156/150K

385/65 R22.5 160J (*) + 315/80 R22,5 156/150K

325/95 R24 162/160K (**)(**)

(*) Mandatory with 9 ton front axle load.

Other tyres available, subject to the Astra technical office approval.

Characteristics and equipment are subject to changes without prior notice
 Technical data and general specifications - validity to be checked according to each individual configuration



BRAKES

Front and rear "duo-duplex" self-adjusting wedge type brakes with automatic play take-up. Total net braking surface 12.368 cm². ABS + EBL system.

Service brake: Pedal controlled air brake, acting on all wheels.

Solo vehicles: two independent circuits, one for 1st and 2nd axle: one for 3rd and 4th axle.

Towing vehicles: three independent circuits, one for 1st and 2nd axle, one for 3rd and 4th axle and another for the trailer.

Emergency brake: Incorporated in service brake.

Parking brake: Mechanical spring-type with pneumatic control acting on 3rd and 4th axle wheels.

IVECO TURBO BRAKE: braking power 255 kW (342 HP)

On request:

1st axle immobiliser system.

OFF/ROAD button for excluding ABS for speed 15 kph.

Front and rear "simplex" self-adjusting brakes system without ABS.



STEERING

ZF 8099 quadrilateral power steering on front axle wheels with variable ratio 1:22.2/1:26.2 with auxiliary cylinder. Circuit with main hydraulic pump on engine and emergency pump on gearbox. Steering rods with self-lubricating joints. Height and inclination mechanical adjustable steering wheel.



ELECTRICAL SYSTEM

Voltage: 24 V

Alternator generator 90 A - 28 V (2520 W).

Accumulators: 2 in series, 180 Ah.

Starter motor 24 V 5,5 kW.

Mechanically controlled electrical circuit breaker.



CAB

Standard white short cab built in galvanized pressed steel with hydraulic tilting up to 60°. Cab suspension with 4 helicoidal springs with coaxial shock absorbers and integrated dampers, anti-roll bar and end-of-stroke pads. Tinted electric door windows. Mechanical rear view mirrors, wide angle mirrors and front view mirror. Internal panels completely washable and fireproof. Compressed air quick coupling for cab cleaning. 4-speed ventilation and heating system with air recirculation system. Air suspended 3-way adjustable driver seat with seat belts. Mechanical passenger seat with seat belts.